

 **excellent!**
Design Center Stuttgart



Design
Award
Winner
2000



red dot

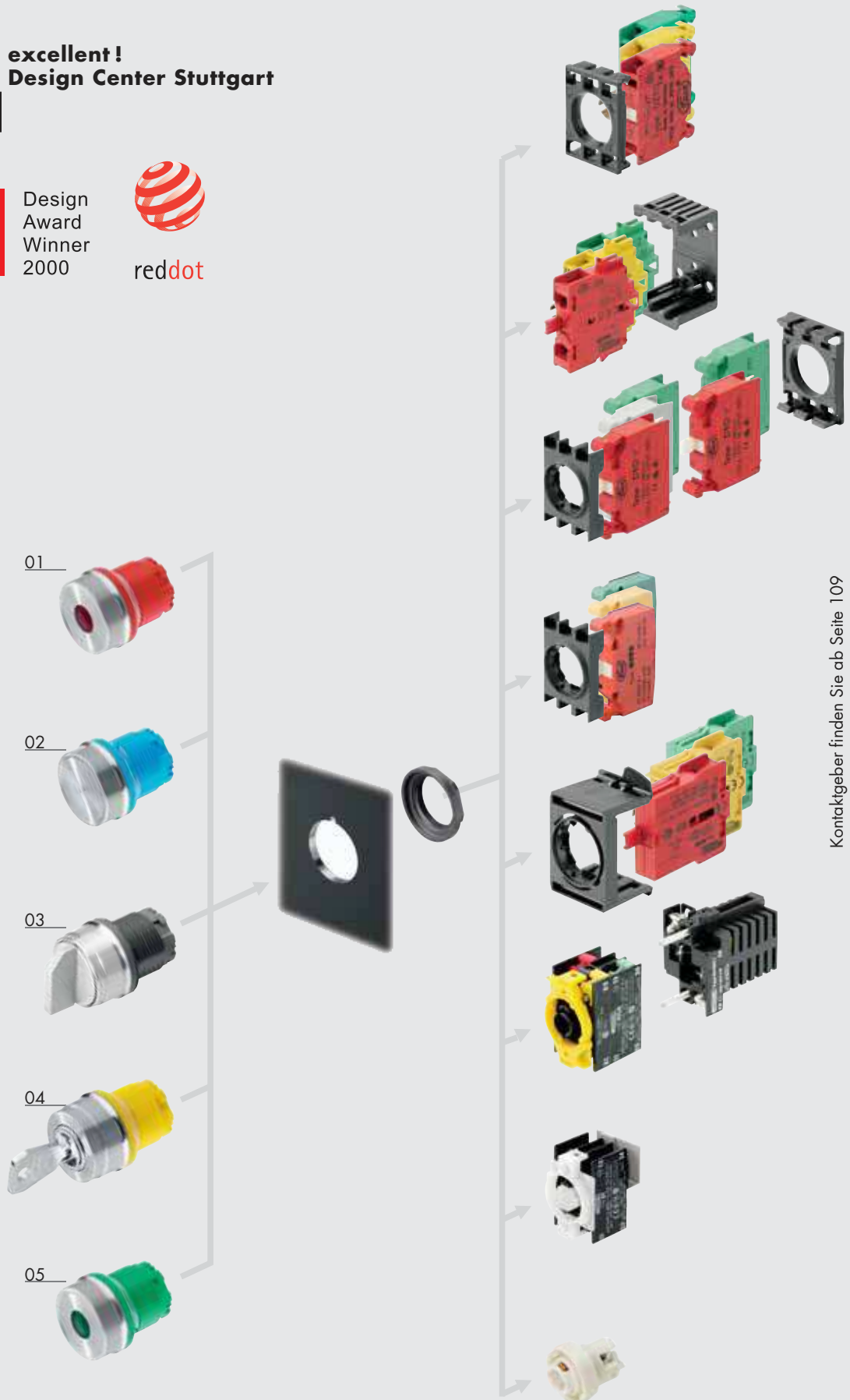

Kontaktgeber finden Sie ab Seite 109

- 01 LeuchtdrucktastenSeite 46
- 02 DrucktastenSeite 46
- 03 WahltagenSeite 46
- 04 SchlüsseltastenSeite 47
- 05 Leuchtvorsätze/Meldeleuchten.Seite 47

Kontaktgeber finden Sie ab Seite 109

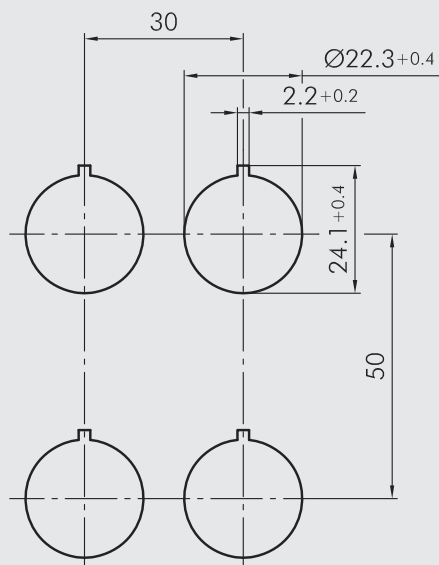

Einbauraster nach DIN EN 50007

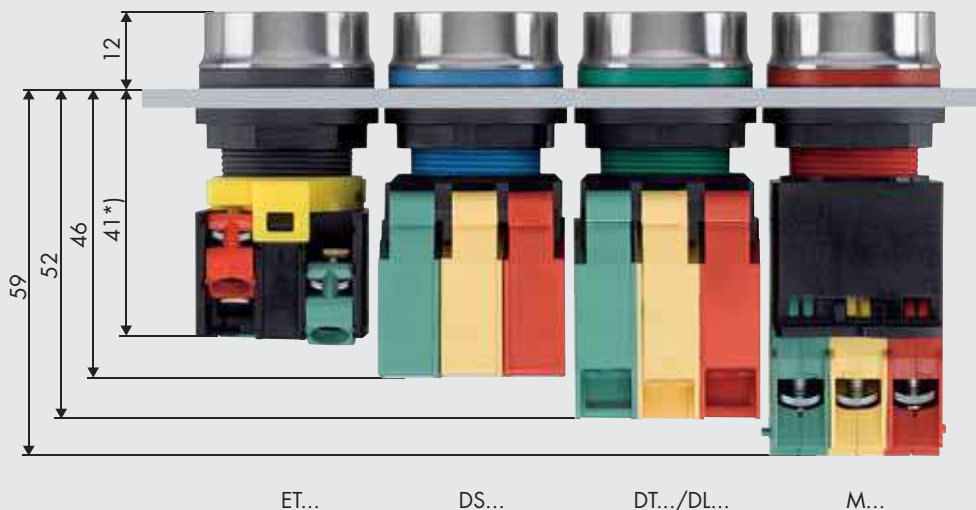

ET...

DS...

DT.../DL...

M...







*) als Leuchttaster 50 mm

Drucktasten - IP69K

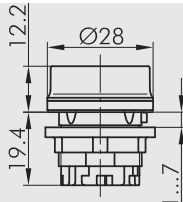
Für Schutzklasse II geeignet.

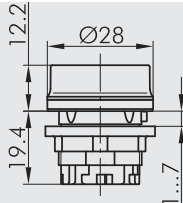
Leucht-Drucktasten / Wahltasten / Schwenktasten - IP69K

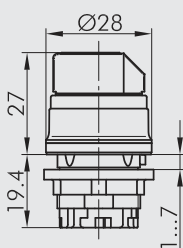
Hülsenrand und Leuchtfläche in den Farben grün-GN, rot-RT, blau-BL, gelb-GB, schwarz-SW, weiß-WS, anthrazit-DG (Leuchtfläche klar).
 Kurzbezeichnung an die Type anhängen, z. B. RVAT_RT

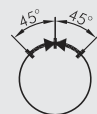
Abbildung	Abmessung	Beschreibung	Type
		Drucktaste	RVAT...
		Leucht-Drucktaste	RVATL...
		Wahltaste	 RVAWA...
			 RVAWB...
			 RVAWC...
		Schwenktaste	 RVASTB...

 = Schaltstellung
 = Federrückzug

**Schlüsseltasten - IP65
Leuchtvorsatz - IP69K**

Für Schutzklasse II □ geeignet.

Hülsenrand und Leuchfläche in den Farben grün-GN, rot-RT, blau-BL, gelb-GB, schwarz-SW, weiß-WS, anthrazit-DG (Leuchfläche klar).
Kurzbezeichnung an die Type anhängen, z. B. RVAT_RT

Abbildung

Abmessung

Beschreibung

Type

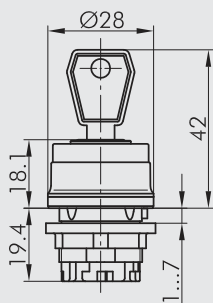

Schlüsseltaste

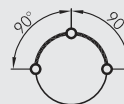

RVASSA12E...

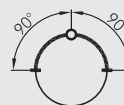

RVASSA13E...



RVASSA14E...



RVASSA15E...



RVASSA17E...



RVASSA18E...

- I = Schaltstellung
- ↶ = Federrückzug
- = Schlüsselabzugstellung

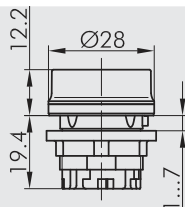

Leuchtvorsatz

RVAN...

	DL	DSL9	DSTI	DTI	DTIV	DTO	DTON	DZL	DZTI	DZTIV	DZTO	DZTON	EL9	EL9R	ET	ETLR	ETLR2	ETR	ETR2	MF	MFL	MFLED230...	MFLED24...	MFLW	ML	MLED230...	MLED24...	MLW	MT97	MTI	MTIV	MTO	MTON	MZL	MZTI	MZTO		
RVAN...	1	1						1					1	1										1	1	1	1											
RVASSA12E...				a	a	a	a		a	a	a	a			1			1	1											B	B	B			B	B		
RVASSA13E...				a	a	a	a		a	a	a	a			1			1	1										B	B	B				B	B		
RVASSA14E...				a	a	a	a		a	a	a	a			1			1	1										B	B					B	B		
RVASSA15E...			1	a	a	a	a		a	a	a	a			1			1	1										B	B					B	B		
RVASSA17E...			1	a	a	a	a		a	a	a	a			1			1	1										B	B					B	B		
RVASSA18E...				a	a	a	a		a	a	a	a			1			1	1										B	B					B	B		
RVASTB...				a	a	a	a		a	a	a	a			1			1	1										D	D					D	D		
RVAT...			2	2	2	2	2		2	2	2	2			1			1	1	1								1	1	1	1	1	1	1	1	1	1	1
RVATL...	2	1	1	2	2	2	2	2	2	2	2	2			1	1	1	1	1	1	1	1	1	1	1	1	1	1	1	1	1	1	1	1	1	1	1	1
RVAWA...			1	a	a	a	a		a	a	a	a			1			1	1										1	1	1	1	1	1	1	1	1	1
RVAWB...				a	a	a	a		a	a	a	a			1			1	1										1	1	1	1	1	1	1	1	1	1
RVAWC...				a	a	a	a		a	a	a	a			1			1	1										1	1	1	1	1	1	1	1	1	1

- 1** optimale Kombination
- 2** max. 2 Kontaktgeber pro Ebene, einrastbar in den Außenpositionen 1+3
- B** max. 2 Modulkontaktgeber
- a** bitte bei den Betägigern den Typenzusatz *_497 angeben

